

Autonics

7 inch TFT Color LCD type Logic Panel

LP-A070

INSTRUCTION MANUAL



Thank you for choosing our Autonics product.
Please read the following safety considerations before use.

Safety Considerations

- Please observe all safety considerations for safe and proper product operation to avoid hazards.
- ⚠ symbol represents caution due to special circumstances in which hazards may occur.

Warning Failure to follow these instructions may result in serious injury or death.
Caution Failure to follow these instructions may result in personal injury or product damage.

Warning

- Fail-safe device must be installed when using the unit with machinery that may cause serious injury or substantial economic loss.** (e.g. nuclear power control, medical equipment, ships, vehicles, railways, aircraft, combustion apparatus, safety equipment, crime/disaster prevention devices, etc.)
Failure to follow this instruction may result in personal injury, economic loss or fire.
- Do not use the unit in the place where flammable/explosive/corrosive gas, high humidity, direct sunlight, radiant heat, vibration, impact, or salinity may be present.**
Failure to follow this instruction may result in explosion or fire.
- Use the unit within the rated specifications.**
Failure to follow this instruction may result in fire or shortening the life cycle of the product.
- Do not connect, repair, or inspect the unit while connected to a power source.**
Failure to follow this instruction may result in fire.
- Check 'Power Wiring', 'Serial Interface', and 'Input/Output Wiring' before wiring.**
Failure to follow this instruction may result in fire.
- In preparation for product damage, communication error, or malfunction, install external emergency stop circuit, forward/reverse interlock circuit, limit switch, emergency stop switch, or other protection circuit.**
Failure to follow this instruction may result in personal injury, economic loss or fire.
- Since Lithium battery is embedded in the product, do not disassemble or burn the unit.**
Failure to follow this instruction may result in fire or product damage.
- Do not disassemble or modify the unit.**
Failure to follow this instruction may result in fire.
- Please contact to us for battery replacement.**

Caution

- Use dry cloth to clean the unit, and do not use water or organic solvent.**
Failure to follow this instruction may result in electric shock or fire.
- When connecting the power input, use AWG 23 cable or over and tighten the terminal screw with a tightening torque of 0.5 to 0.8N·m.**
Failure to follow this instruction may result in fire or malfunction due to contact failure.
- Keep the product away from metal chip, dust, and wire residue which flow into the unit.**
Failure to follow this instruction may result in fire or product damage.
- Do not push over 2 point at the same time.**
Failure to follow this instruction may result in malfunction.
- Do not put any heavy object on the front screen.**
Failure to follow this instruction may result in malfunction due to deformation of LCD and touch panel.

Ordering Information

LP-A070-T9D6-C5R	I/O connector	R	Ribbon cable connector
	I/O composition	T	Terminal block connector
	Module	5	IN: 16-point, OUT: 16-point
	Interface	C	All-in-one type
	Power supply	6	RS232C, RS422, USB HOST, USB DEVICE, Ethernet
	Color	7	RS232C(2), USB HOST, USB DEVICE, Ethernet
	Display unit	D	24VDC
	Screen size	9	16,777,216 color
	Series	T	TFT Color LCD
	Item	070	7 inch
		A	A series
		LP	Logic Panel

※The above specifications are subject to change and some models may be discontinued without notice.
※Be sure to follow cautions written in the instruction manual, user manual and the technical descriptions (catalog, website).

Specifications

General specifications

Model	LP-A070-T9D6-C5R(T)	LP-A070-T9D7-C5R(T)
Power supply	24VDC	
Allowable voltage range	90 to 110% of power supply	
Power consumption	Max. 7.2W	
Serial interface	Each port of RS232C, RS422	Two ports of RS232C
USB interface	Each of USB Host, USB Device (USB2.0)	
Ethernet interface	IEEE802.3(U), 10/100Base-T	
Real-time controller	RTC embedded	
Battery life cycle	3 years at 25°C	
Insulated resistance	Over 100MΩ (at 500VDC megger)	
Ground	3rd grounding (max. 100Ω)	
Noise immunity	±0.5kV the square wave noise (pulse width: 1μs) by the noise simulator	
Withstanding voltage	500VAC 50/60Hz for 1 minute	
Vibration	Mechanical	0.75mm amplitude at frequency of 10 to 55Hz (for 1 min) in each X, Y, Z direction for 1 hour
	Malfunction	0.5mm amplitude at frequency of 10 to 55Hz (for 1 min) in each X, Y, Z direction for 10 min
Shock	Mechanical	300m/s ² (approx. 30G) in each X,Y,Z direction for 3 times
	Malfunction	100m/s ² (approx. 10G) in each X,Y,Z direction for 3 times
Environment	Ambient temperature	0 to 50°C, storage: -20 to 60°C
	Ambient humidity	35 to 85% RH, storage: 35 to 85%RH
Protection structure	IP65 (front panel, IEC standard)	
Accessory	Fixing bracket: 4, battery (included)	
Approval	CE	
Weight ^{※1}	Approx. 742g (approx. 540g)	

※1: The weight includes packaging. The weight in parenthesis is for unit only.
※2: Environment resistance is rated at no freezing or condensation.

Performance specifications

Display performance

LCD type	TFT Color LCD
Resolution	800×480 dot
Display area	152.4×94.44mm
Color	16,777,216 color
LCD view angle	Within each 50°/60°/65°/65° of top/bottom/left/right
Backlight	White LED
Luminance	Max. 300cd/m ²
Luminance adjustment	Adjustable by software

Graphic drawing performance

Language ^{※1}	Korean, English
Text	Bitmap ASCII and vector font
Graphic drawing memory	64MB
Number of user screen	100 pages
Touch switch	Analog touch (resistive type)

Interface type

LP-A070-T9D6-C5R(T)	RS232C, RS422, USB Host, USB Device, Ethernet
LP-A070-T9D7-C5R(T)	RS232C: 2, USB Host, USB Device, Ethernet

Input		Output	
Input point	16-point	Out point	16-point
Insulation method	Photo coupler insulation	Power supply	24VDC
Rated input voltage	24VDC	Insulation method	Photocoupler insulation
Input resistance	Contact X0 to X8: approx. 10mA Contact X9 to XF: approx. 4mA	Rated load voltage	24VDC
Voltage range	19.2-28.8VDC	Allowable load voltage range	19.2-28.8VDC
Input resistance	Contact X0 to X8: 3.3kΩ Contact X9 to XF: 5.6kΩ	Max. load current	0.1A/1 point, 1.6A/1COM
Response time	0.5ms	Max. voltage falling when ON	Max. 0.2VDC
Common method	16-point/1 COM	Common method	16-point/1 COM
Acceptable wire	0.3 to 0.7mm ²	Acceptable wire	0.3 to 0.7mm ²

Control performance

Command	Basic command: 28, application command: 236
Program capacity	8K step
Processing time	Average: approx. 1μs/basic command, application command
I/O control type	Batch processing
Computer control mode	Repeated-doubling method, interrupt processing
Device range	Refer to 'LP-A Series user manual'
Special function	Positioning function, high speed counter ^{※2}

※1: Supported language can be added.
※2: Please refer to 'LP-A Series user manual' for more special function.

Dimensions

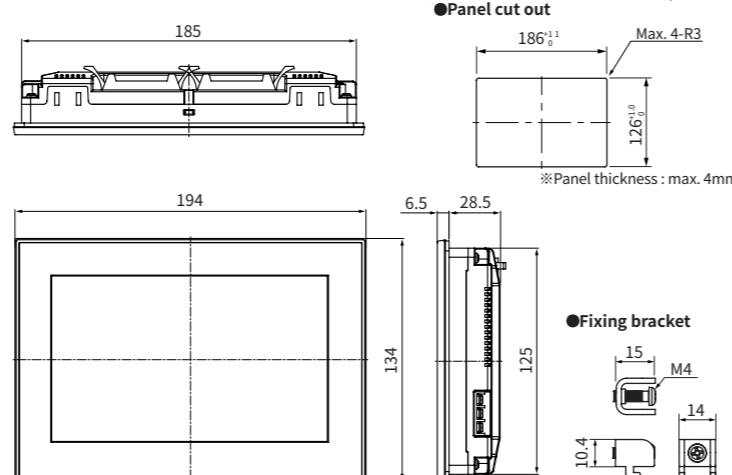

Unit Description

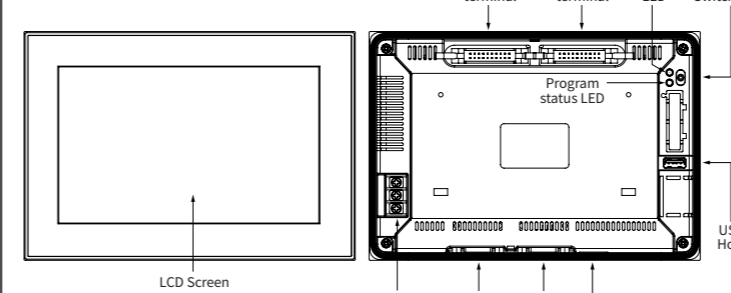

Program status LED

LED color	LED status	Program status
Green	ON	Run
Green	Flashing	Pause
Red	Flashing	Error
Orange	ON	atLogic debugging

Serial port (RS232C/RS422)

All devices connectable to the product including PC, PLC, serial printer, barcode reader, and dedicated connectors can be connected in to both RS232C and RS422 ports.

Port	Pin	Port	Pin		
RS232C RS232C-A RS232C-B	1	Non-Used	RS422	1	TXD+
	2	RXD		2	RXD+
	3	TXD		3	Non-Used
	4	DTR		4	Non-Used
	5	SG		5	SG
	6	DSR		6	TXD-
	7	Non-Used		7	RXD-
	8	Non-Used		8	Non-Used
	9	Non-Used		9	Non-Used

Ethernet port

For connecting LAN cable and hub, use direct cable, and for connecting PC directly, use cross cable.

USB

Type	USB Host	USB Device
Function	<ul style="list-style-type: none"> Transferring/Copying data between storage and LP-A070 Firmware upgrade Bar-code reader Printer 	<ul style="list-style-type: none"> Uploading/Downloading a atDesigner project file Used as external storage by connecting to PC

USB HOST can cover up to 32GB of external storage.
It supports only external storage of FAT16 and FAT32 file system.

Power Wiring

- For power supply, use the wire of which cross section is at least 0.75mm² and use the wire of which cross section is at least 1.25mm² for grounding.
- Use round terminal with at least 3mm of internal diameter and less than 6mm of external diameter.
- Do not apply power before power line connection.
- Check power polarity.
- Tighten the terminal screw with 0.5 to 0.8N·m torque.
- Ground resistance should be less than 100Ω and ground it separately.

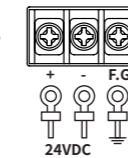

Installation

- Set LP-A070 in panel.
- Set fixing brackets in 4 slots (2 slots is in upper side, 2 slots is in lower side).
- Tighten fixing bracket with M4 screw driver and tightening torque is 0.3 to 0.5N·m.

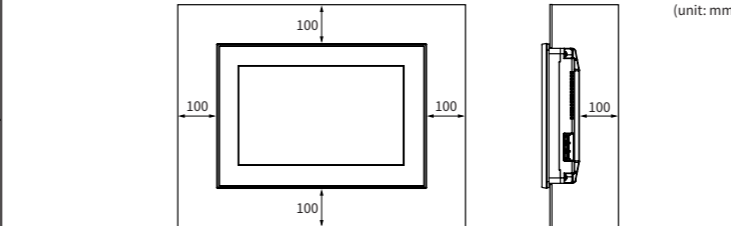
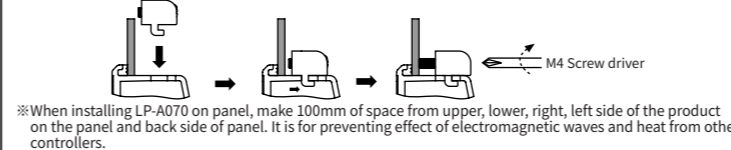

Software

- atDesigner**
atDesigner is for editing project and user screen.
- atLogic**
atLogic is for writing and debugging program for LP-A070. Computer specification for atDesigner and atLogic is as below.

Item	atDesigner		atLogic	
	Minimum spec	Recommended spec	Minimum spec	Recommended spec
Operating system	Windows XP/Vista/7/8/10		Windows 7/8/10	
CPU	Pentium4 1.6GHz or above	Intel Core i5-2nd generation 2500 or above	Pentium4 or above	Pentium Dual Core
Memory	Min. 4GB	Min. 8GB	512MB	1GB
Hard disk	Min. 4GB	Min. 8GB	1GB (available space)	5GB (available space)
Resolution	Min. 1280×1024	Min. 1920×1080	1024×768	1280×1024

Firmware

Please refer to 'LP-A Series user manual' for firmware upgrade.

Input/Output Wiring

1. LP-A070-T9D6(7)-CSR

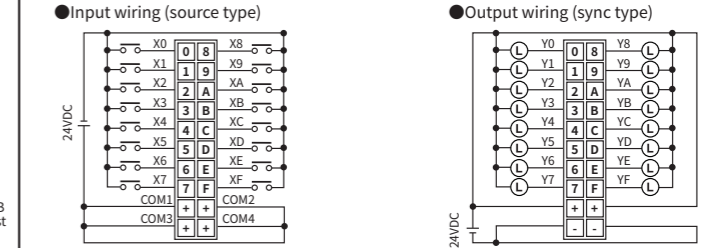

2. LP-A070-T9D6(7)-CST

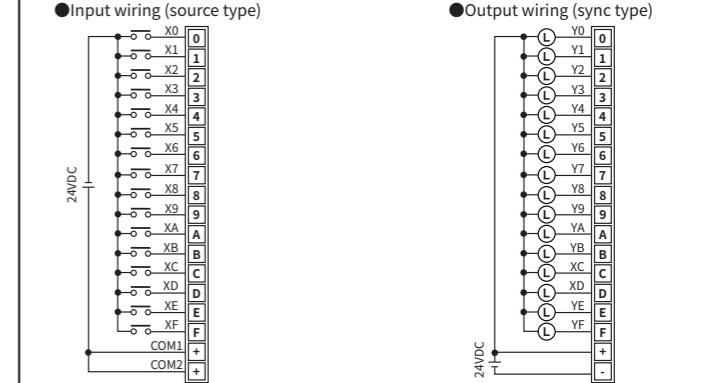

※Check the number of pin on the rear case before wiring.

Manual

For the detail information and instructions, please refer to user manual and user manual for communication, and be sure to follow cautions written in the technical descriptions (catalog, website).

- atDesigner user manual**
It describes how to design user screen and contains information about LP-A070 HMI function and how to use it.
- atLogic user manual, atLogic programming manual**
It contains how to install and use atLogic, how to program, and commands for LP Series.
- GP/LP user manual for communication**
It describes how to connect with external devices such as PLC.
- LP-A Series user manual**
It describes general information about installation and system of LP-A070.

Cable (sold separately)

Communication cables connectable into external devices such as PLC are sold separately. Please refer to 'GP/LP user manual for communication' for communication cable.

Battery Replacement

Please contact our service center to replace battery. It may cause an explosion or a fire when using improper battery.

Cautions during Use

- Follow instructions in 'Cautions during Use'. Otherwise, it may cause unexpected accidents.
- 24VDC power supply should be insulated and limited voltage/current or Class 2, SELV power supply device.
- Install a power switch or circuit breaker in the easily accessible place for supplying or disconnecting the power.
- Operate the product after supplying power to the product, input/output equipment, and load. If operate product before supplying power, it may result in output error or malfunction.
- Keep away from high voltage lines or power lines to prevent inductive noise. Do not use near the equipment which generates strong magnetic force or high frequency noise.
- Make a required space around the unit for radiation of heat, and do not block ventilation openings.
- Do not push the touch panel with a hard and sharp object or push the panel with excessive force. It may result in fire or malfunction.
- When skin is smeared with liquid crystal from the broken LCD, rinse with running water for over 15 minutes.
- If it gets into the eyes, rinse eyes with running water for over 15 minutes and contact a doctor.

①Indoors (in the environment condition rated in 'Specifications')
②Altitude max. 2,000m
③Pollution degree 2
④Installation category II